

Data Sheet



Article number: 586LX2

Description: Silencers LX-02, - G 1/4"
Silencer With Hi-Flow

Measures

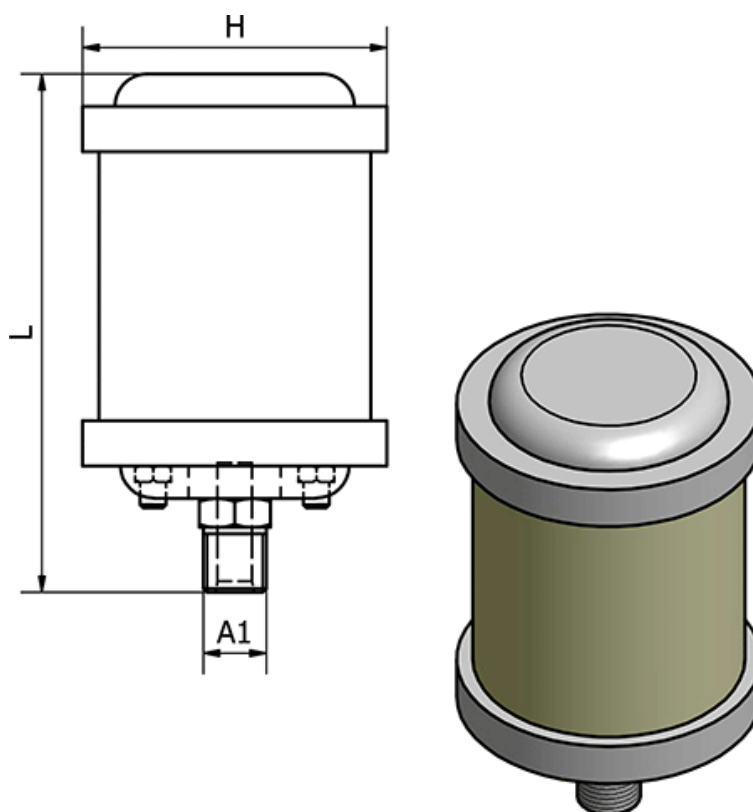

Flow l/min at 5 bar = 2350

H = 47

L = 111

Thread A1 = G 1/4"